

Origami Checkers

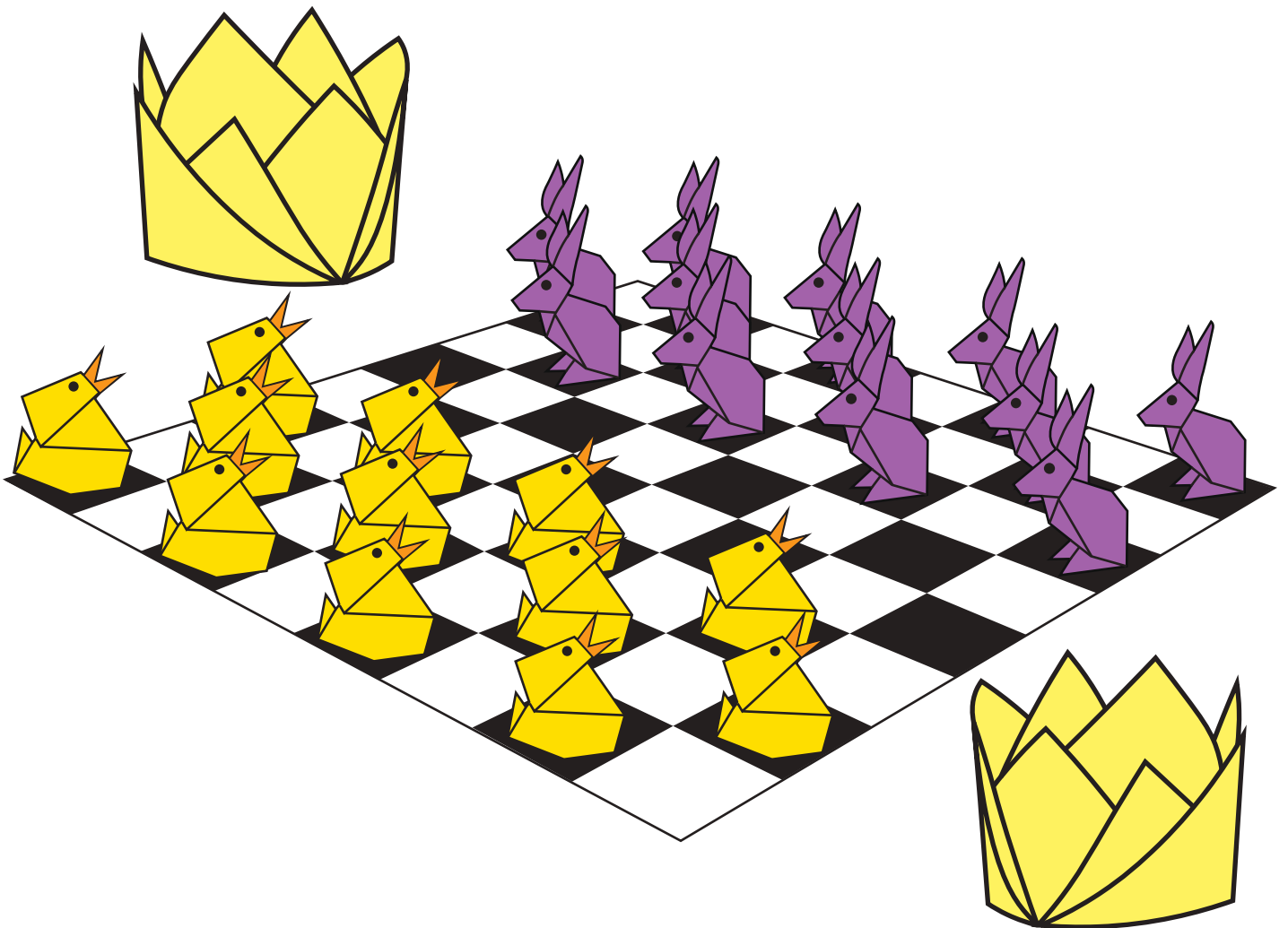



www.lovepaper.org



We'd love to see what you've done!
Share on social media using [#LovePaperCreations](https://twitter.com/lovepapercreations)

For more great activities, go to www.lovepaper.org/creations

-  @LovePaperUK
-  @LovePaperCampaign
-  @LovePaperUK

Origami Checkers



www.lovepaper.org

Recommended Size: 36 cm x 36 cm

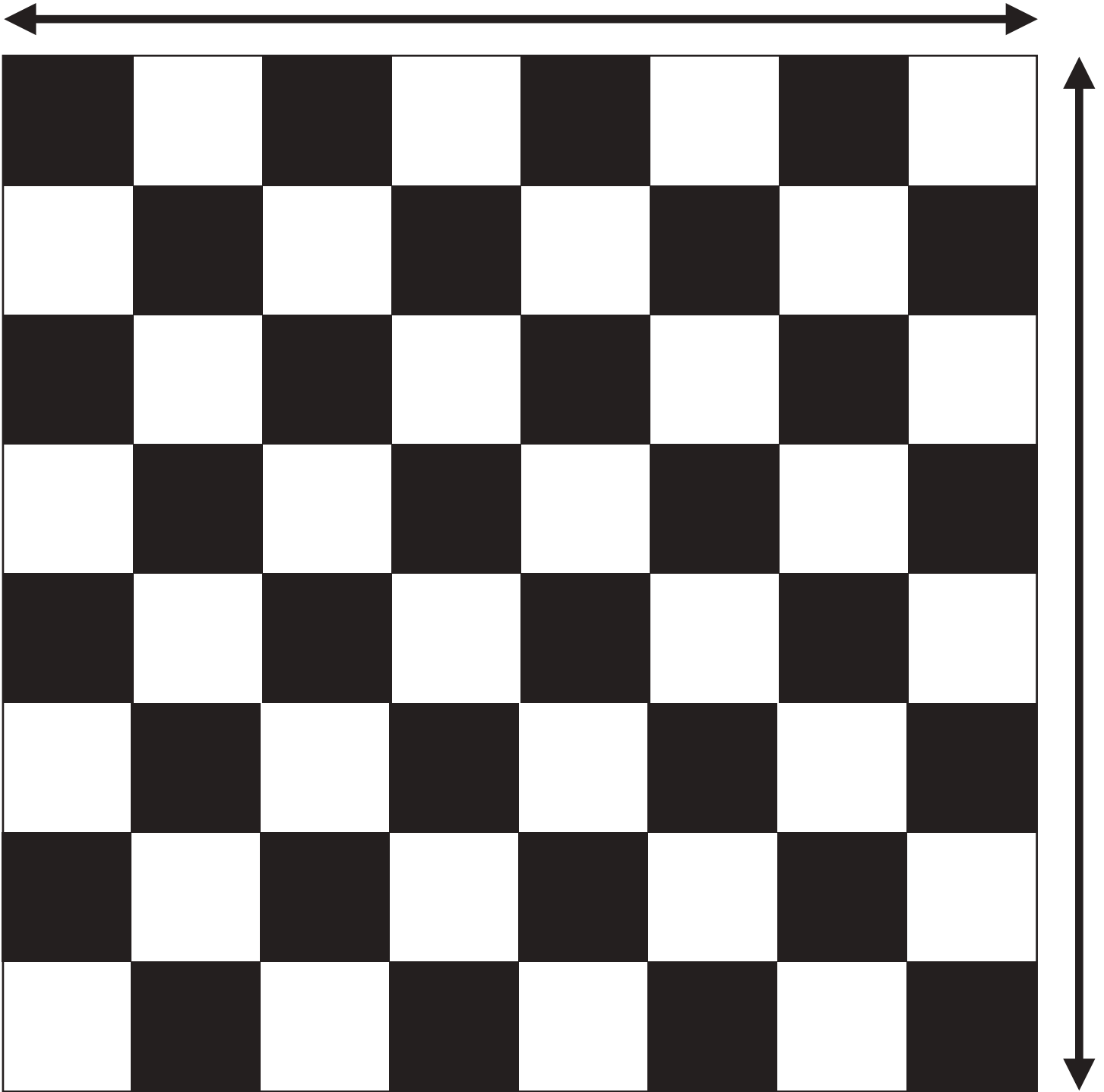

Game Pieces And Board

Checkers is a board game played between two people on an 8x8 checked board like the one shown in the previous sheet

Each player has 12 pieces either the chick or the bunny that fit inside each of the boxes on the board. The pieces are placed on every other dark square and then staggered by rows, like shown on the first page.

Taking A Turn

Typically bunny pieces move first. Each player takes their turn by moving a piece. Pieces are always moved diagonally and can be moved in the following ways:

- Diagonally in the forward direction (towards the opponent) to the next dark square.
- If there is one of the opponent's pieces next to a piece and an empty space on the other side, you jump your opponent and remove their piece. You can do multiple jumps if they are lined up in the forward direction. Importantly if you have a jump, you have no choice but to take it.

King Pieces

The last row is called the king row. If you get a piece across the board to the opponent's king row, that piece becomes a king. For this the crown origami piece can now be placed on your king bunny or chick. King pieces can move in both directions, forward and backward.

Once a piece is 'kinged', the player must wait until the next turn to jump out of the king row.

Winning The Game

You win the game when the opponent has no more pieces or can't move (even if they still have pieces on the board). If neither player can move then it is a draw or a tie.

Origami Chick



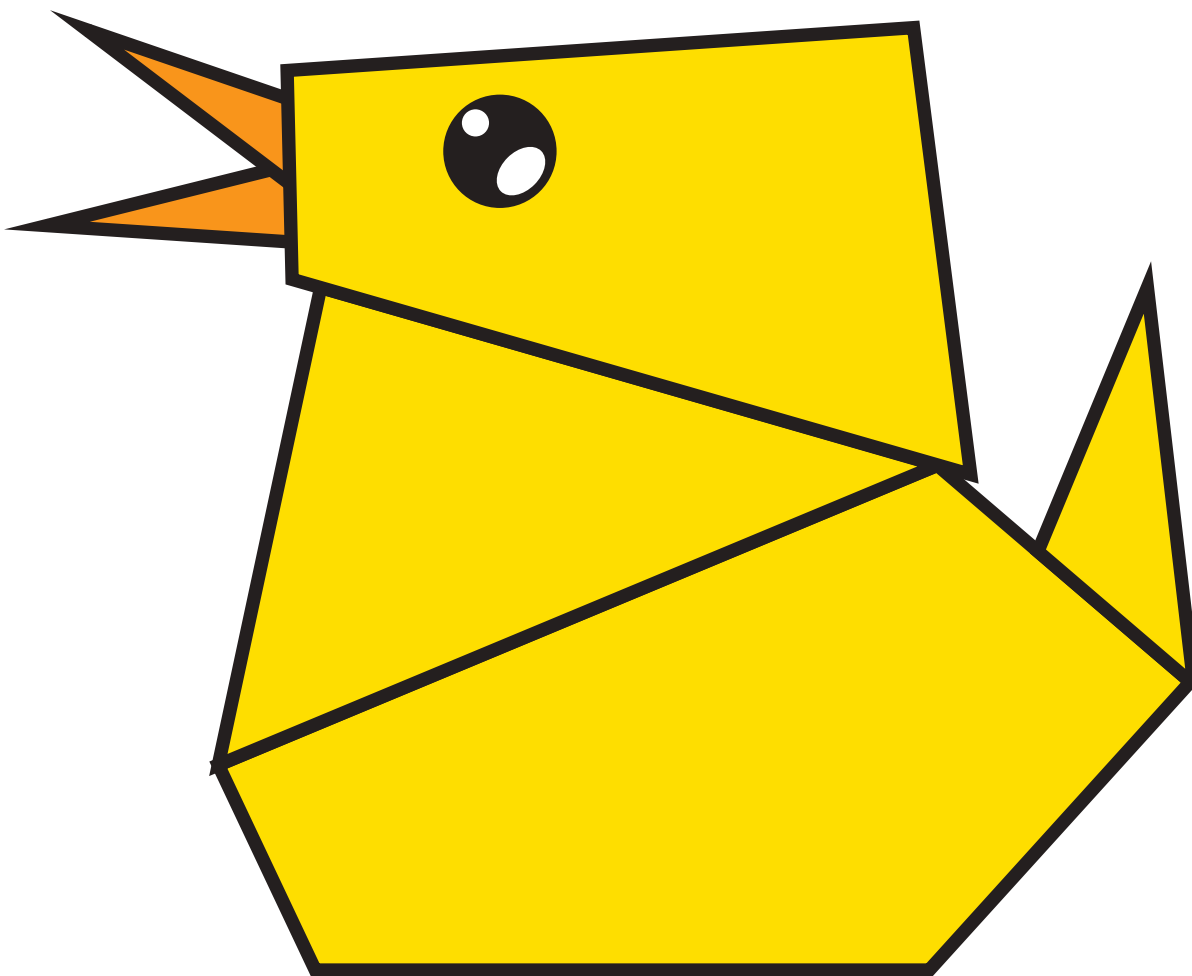

www.lovepaper.org



We'd love to see what you've done!
Share on social media using [#LovePaperCreations](https://twitter.com/lovepapercreations)

For more great activities, go to www.lovepaper.org/creations

 @LovePaperUK
 @LovePaperCampaign
 @LovePaperUK

Origami Chick

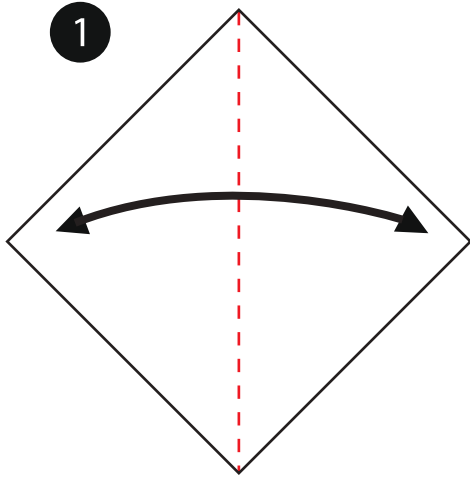

1 Fold along the seam in half.

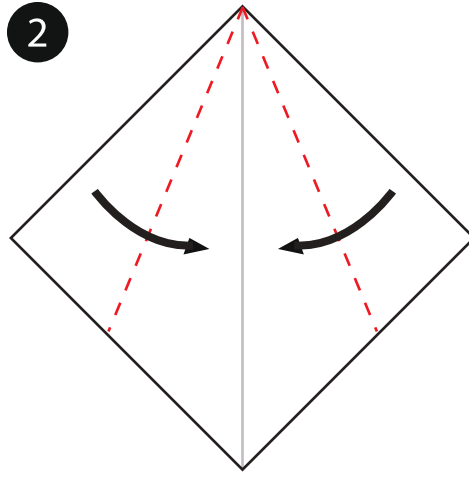

2 Fold along the seam towards the centre grey line.

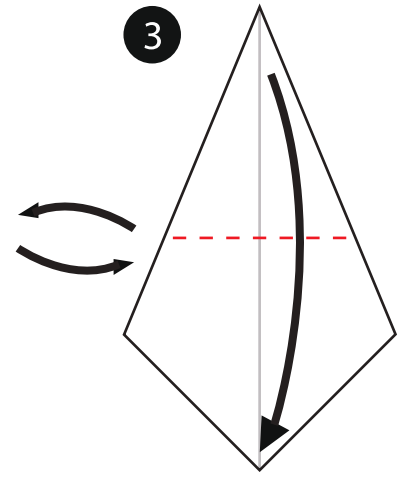

3 Flip the shape and fold along seam from top to bottom.

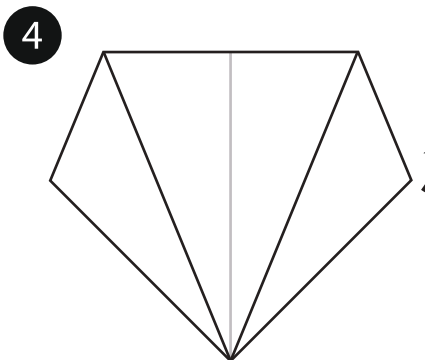

4 Flip the shape.

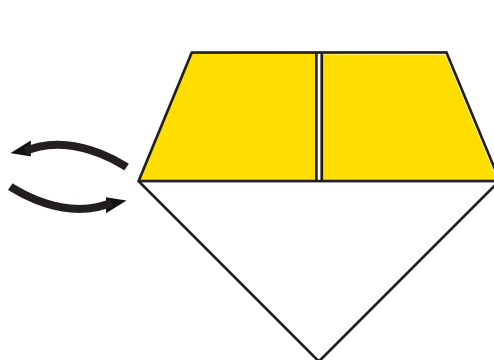

5 Open up the highlighted squares and flatten to replicate look of step 5.

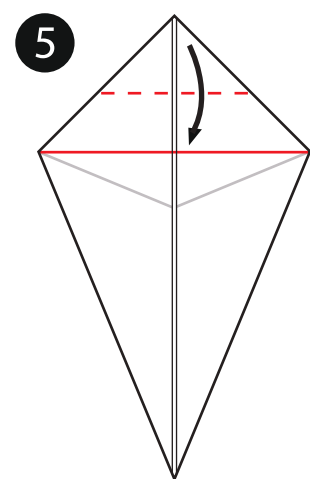

6 Fold along seam and allow tip to align with red line.

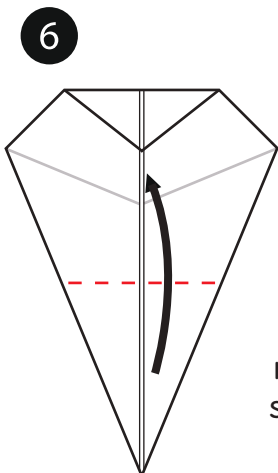

7 Fold along seam and replicate the look of the second image in step 6.

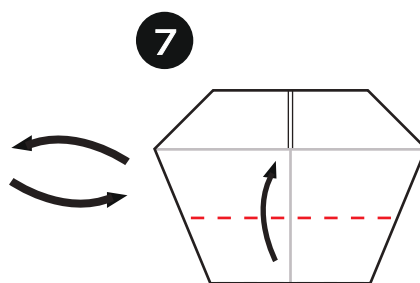
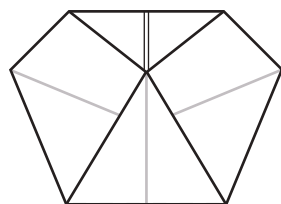

7 Flip the shape and fold along the seam so that shape resembles second image of step 7.

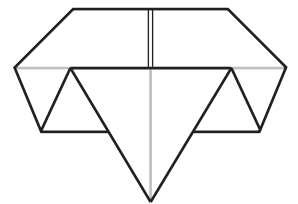

8

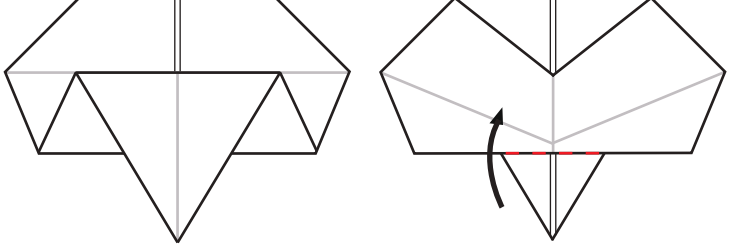

Flip the shape and and fold along the dotted line and replicate the shape in step 9.

9

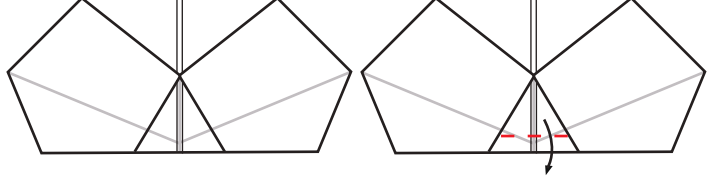

Fold down on the dotted line to replicate the shape of the first image in step 10.

10

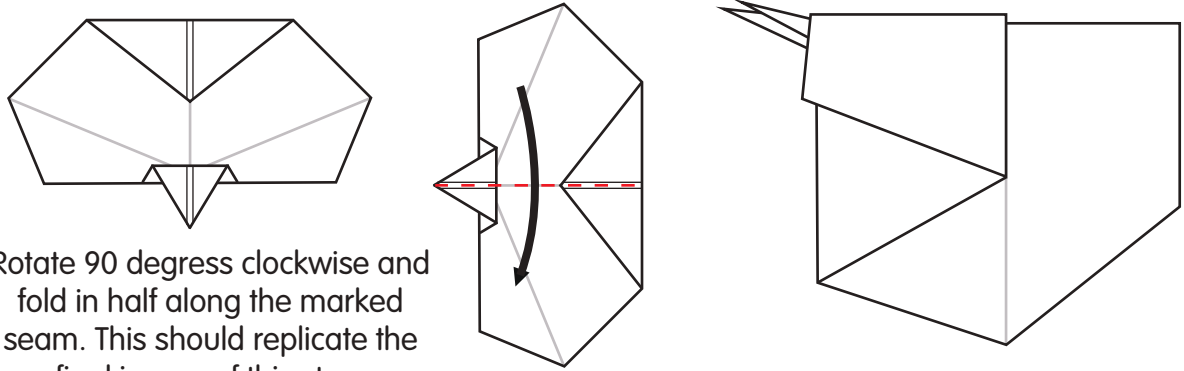

Rotate 90 degress clockwise and fold in half along the marked seam. This should replicate the final image of this step.

11

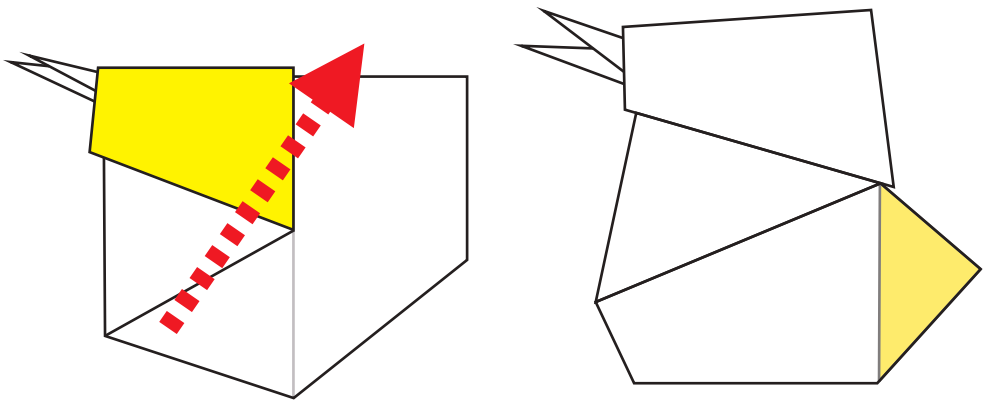

To make the next step of the duck pinch the shape in the highlighted area and slide in the direction of the red arrow. For the final touch take the faded inside highlighted are of the shape and fold it out to look like the tail of the chick.

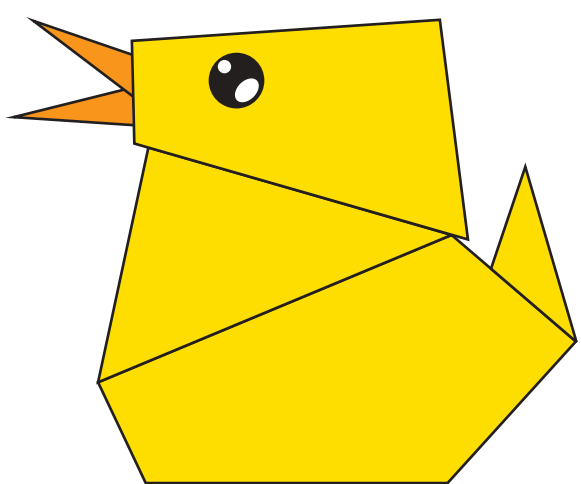

Origami Rabbit



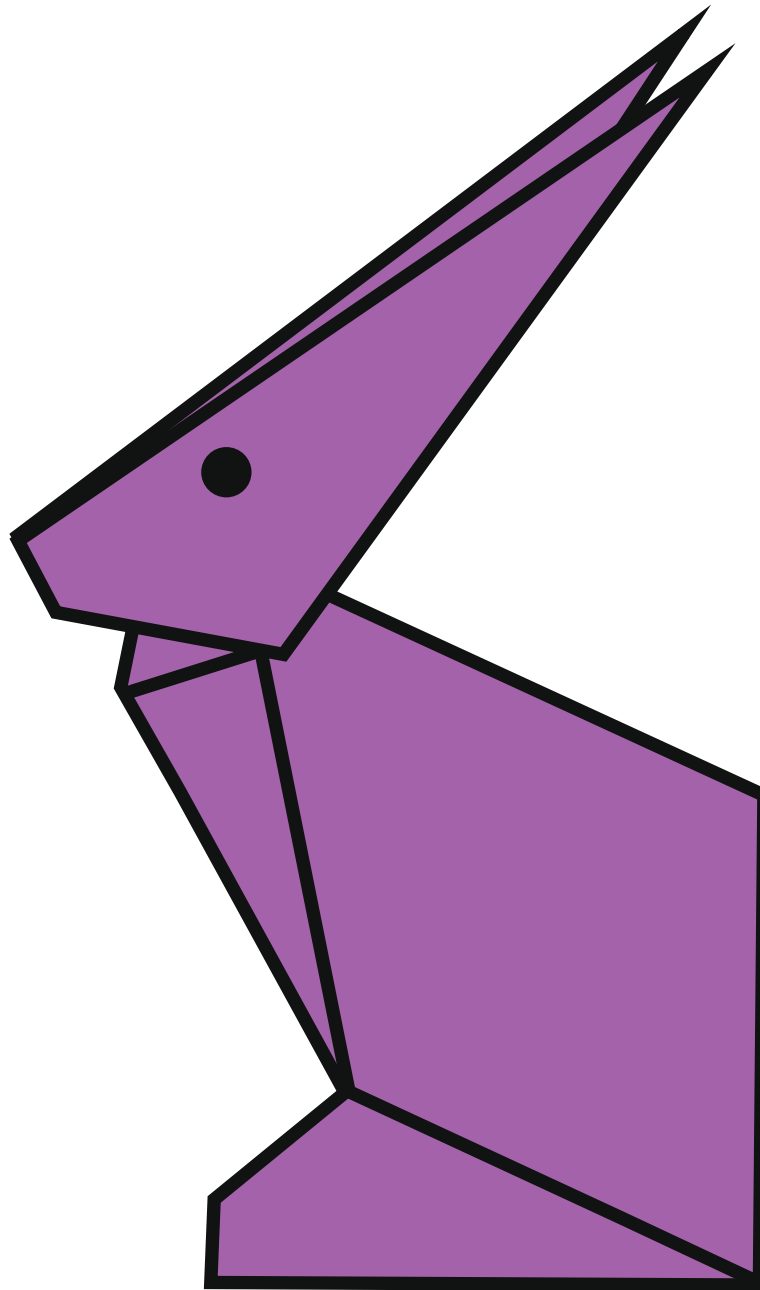

www.lovepaper.org



We'd love to see what you've done!
Share on social media using [#LovePaperCreations](https://twitter.com/lovepapercreations)

For more great activities, go to www.lovepaper.org/creations

 @LovePaperUK
 @LovePaperCampaign
 @LovePaperUK

Origami Rabbit



www.lovepaper.org

1

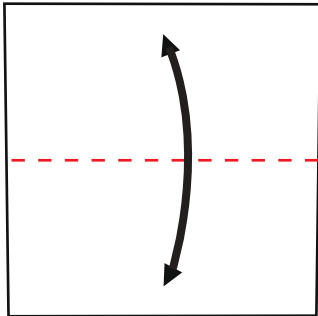

Fold along the seam in half.

2

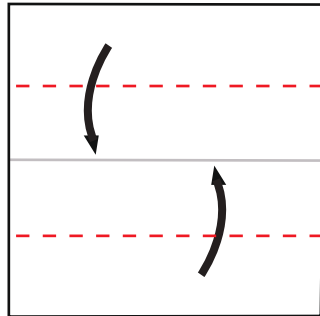

Fold along both seams to the centre crease.

3

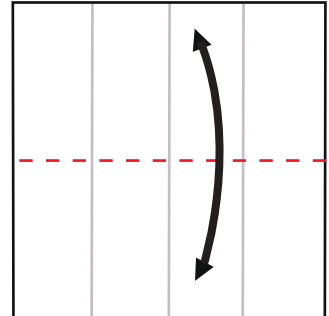

Rotate 90 degrees and repeat step 1.

4

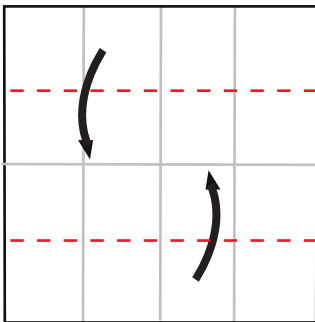

Repeat step 2.

5

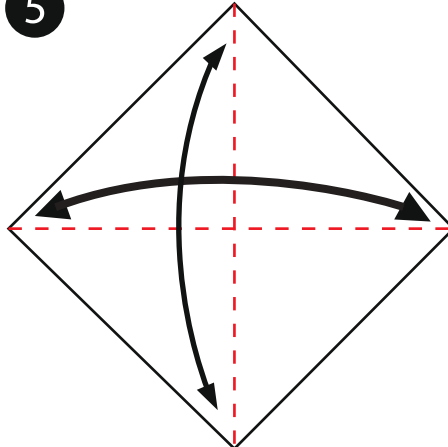

Fold along both diagonals to create creases.

6

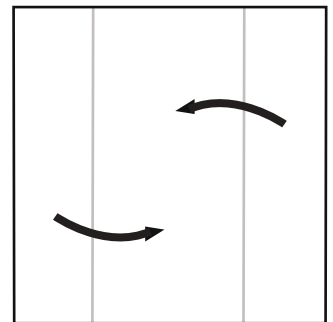

Fold in along these two creases to centre fold of the shape.

7

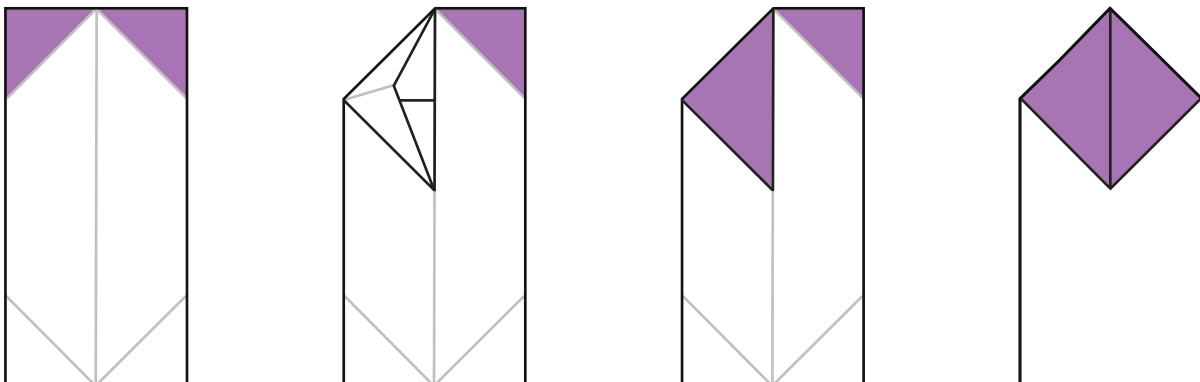

Firstly, open the folded doors of the shape in the highlighted area of the first image in this sequence. When folding down, the shape should begin to resemble the second image. And finally flatten the shape to resemble the third image. Repeat these steps for the other side so the shape resembles the fourth image.

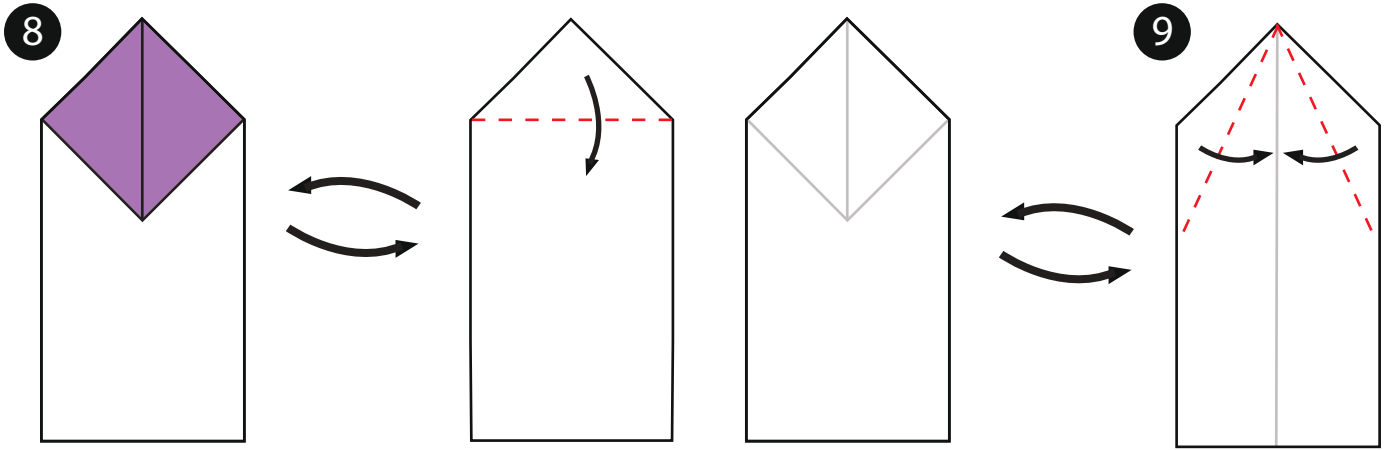

Flip the shape and fold down the red dotted line so that the shape resembles the third image in step 8.

Fold along both seams to the centre crease.

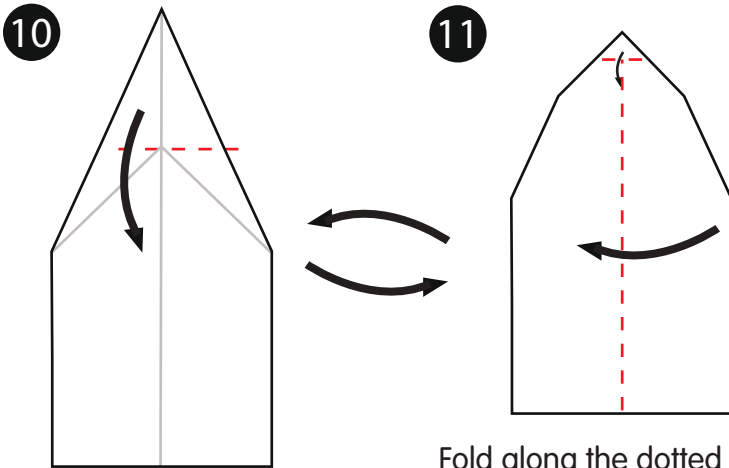

Fold along the dotted seam.

Fold along the dotted seam at the top first. Then fold in half to create a shape similar to the one in step 12.

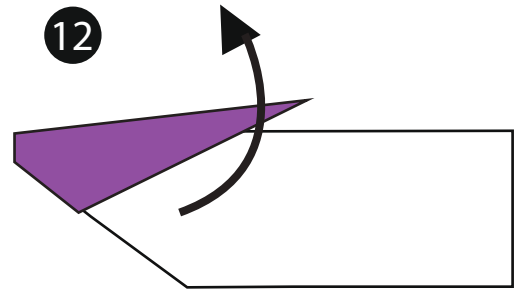

To make the next step of the rabbit pinch the shape in the highlighted area and slide in the direction of the purple arrow. The shape should start to resemble step 13.

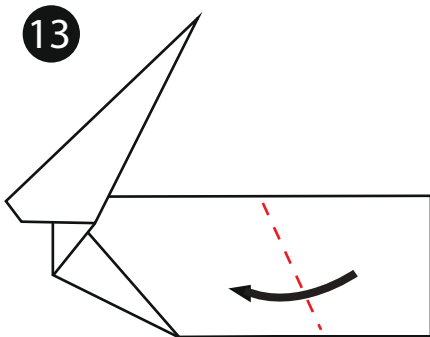

Fold along the dotted seam. And your shape should start to resemble step 14.

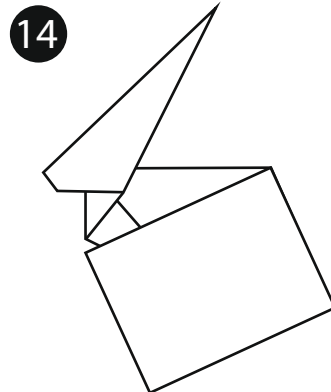

Flip back the fold just made.

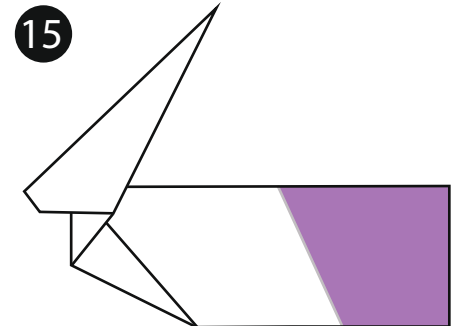

Fan out the middle of the high-lighted area and push in the spine to resemble the shape in step 16.

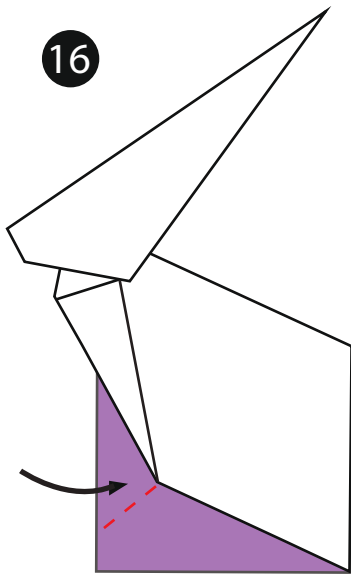

16
Tuck in the middle of the highlighted are to create the look of the feet as shown in step 17.

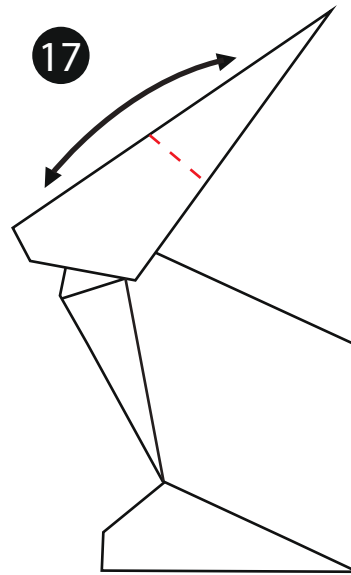

17
Fold down on the dotted seams on both sides of the rabbit's head, this creates the creases for the ears.

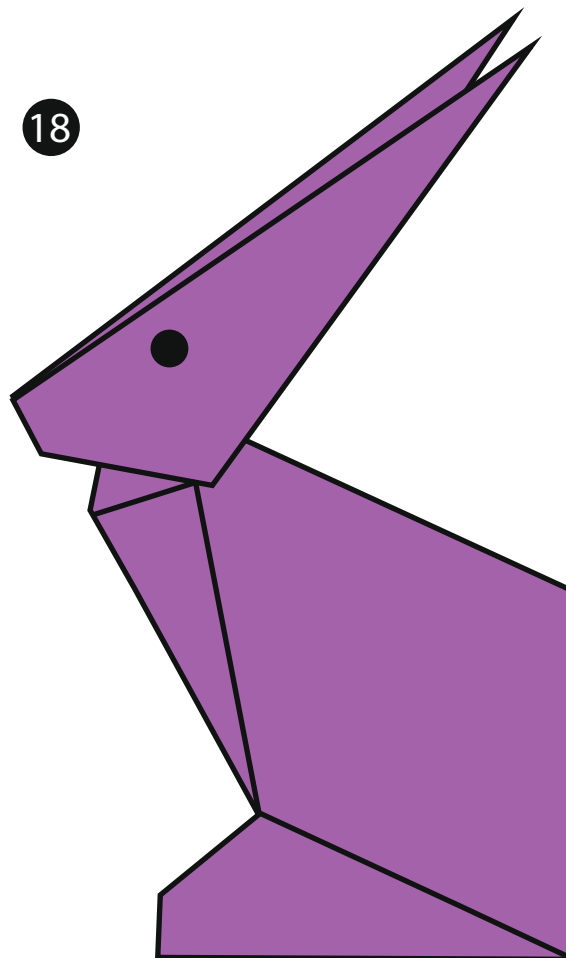

18

This is the finished look for the rabbit!

Origami Crown



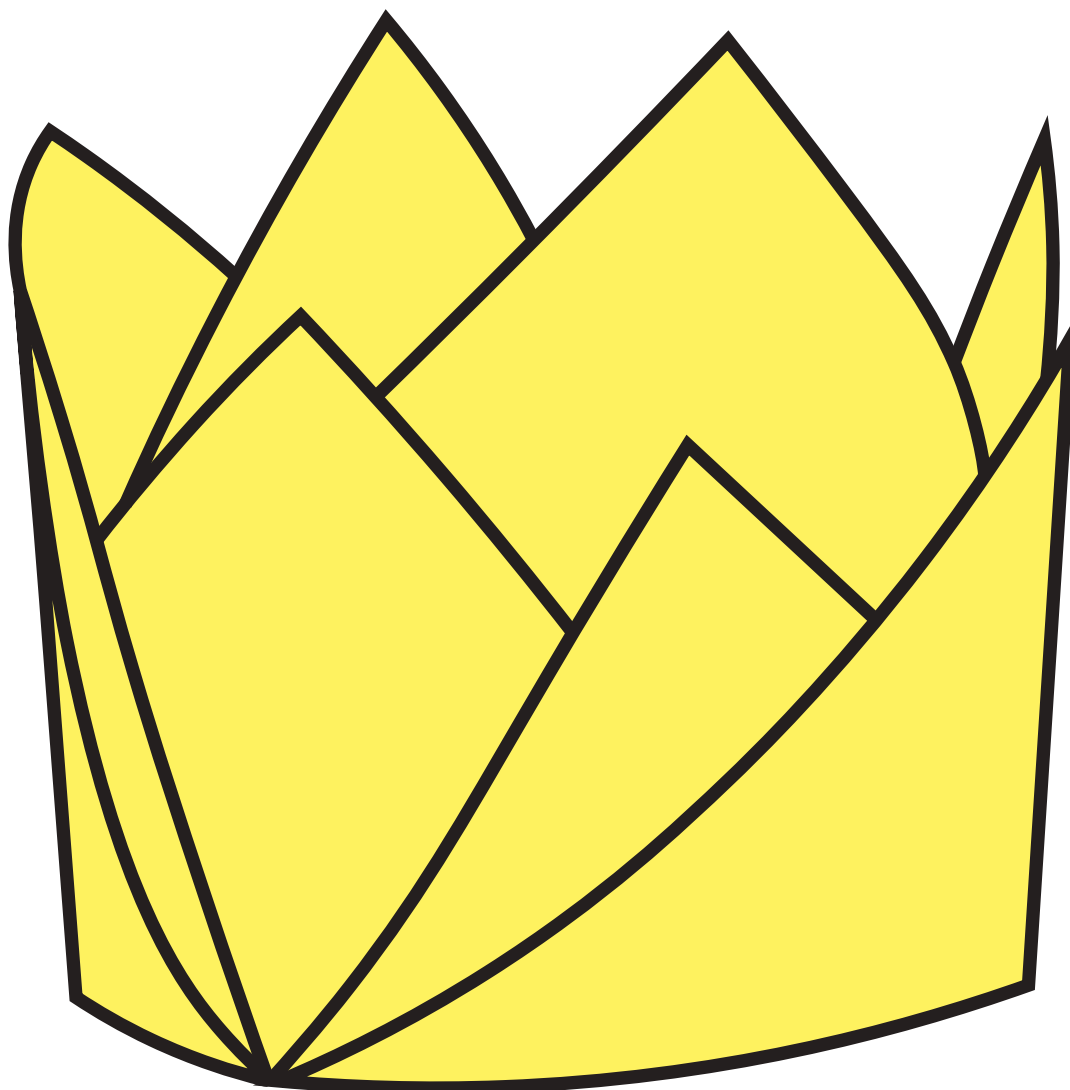

www.lovepaper.org



We'd love to see what you've done!
Share on social media using [#LovePaperCreations](https://twitter.com/lovepapercreations)

For more great activities, go to www.lovepaper.org/creations

 @LovePaperUK
 @LovePaperCampaign
 @LovePaperUK

Origami Crown



www.lovepaper.org

1

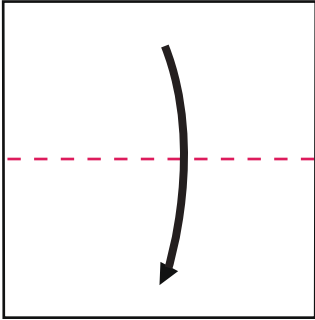

Fold paper in half.

2

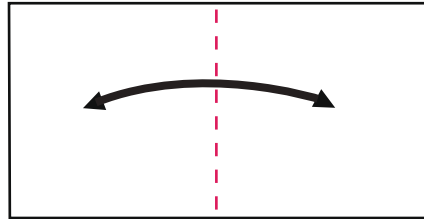

Fold paper in half again.

3

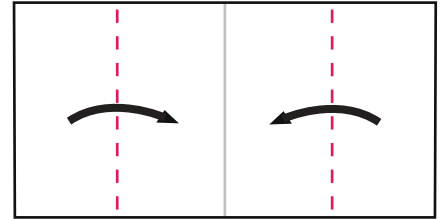

4

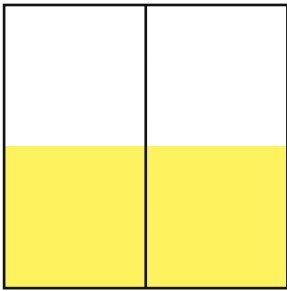

Open the flaps at the top of the high-lighted area and keep pulling to the edge until a triangle shape forms and can be flattened to resemble step 5.

5

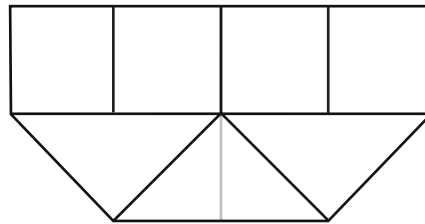

6

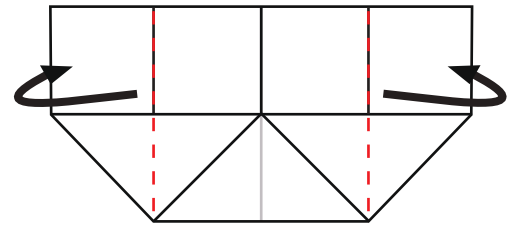

Fold along the dotted lines so that the edges meet the centre of the other side. Both sides of the shape should look identical.

7

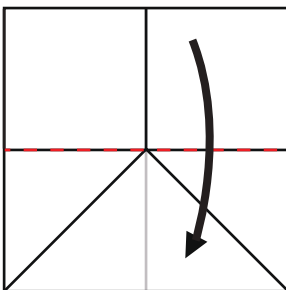

Fold the paper in half from the red dotted seam. It is important to only fold down one half of the top.

8

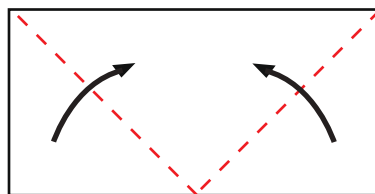

Fold the paper along red dotted lines to the top of the page.

9

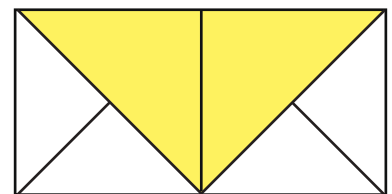

This is how the shape should look at this stage. With the high-lighted area open the flap of each and flatten the shape to look like step 10.

10

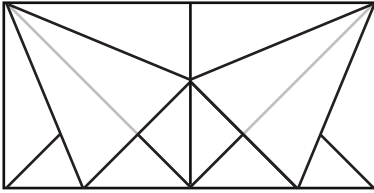

11

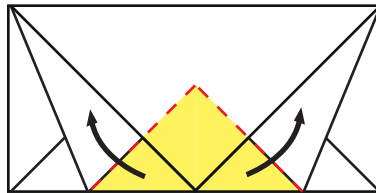

The high-lighted area is under the surface of the shape tuck these triangles into the shape so they are hidden.

12

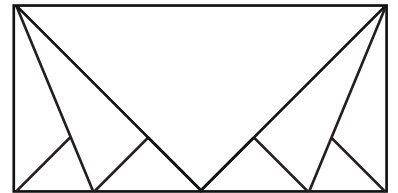

This is one half of the crown completed. Repeat steps 7 through to 11 for the other side.

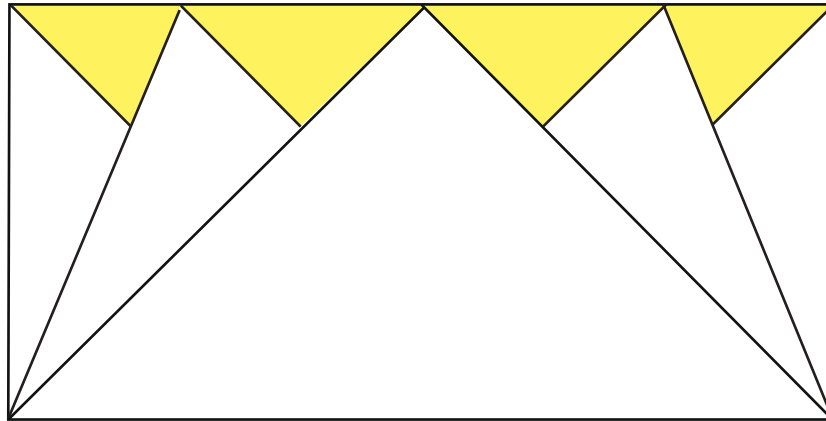

With both sides of the crown looking like this it is now onto the final stop to complete the crown. With the high-lighted middle section push it down and keep rounding it out until the crown fully forms. Below are some reference images to compare with.

